

## Download instructions

1. Go to [autodesk.com/Fusion360](https://autodesk.com/Fusion360)
2. In the center of the screen, click on an orange box labelled "Download free trial"

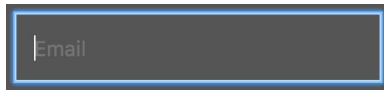

3. Enter your email in the box given, then click "download free trial"



4. When finished downloading, open the downloaded file
5. Verify your email by logging into your email account, and create a password

## Project: Build a house

Tip: On the bottom to the right, you will see . Click on it and click “multiple views” to split your screen into 4 panels for easier access.

1. Select “create” -> “box”, pick any of the yellow boxes that show up, and draw a square around the center.

2. Set the length and width to be 150, and the height to be 100.

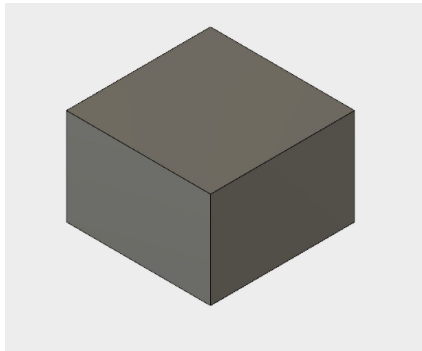

3. Select “modify” -> “chamfer”, and then click on the left and right edges on the top of the box.

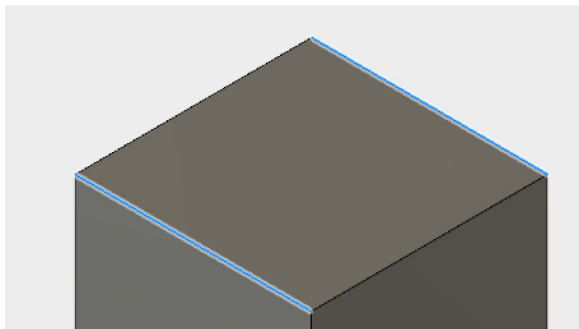

4. Type in 75 and press enter.

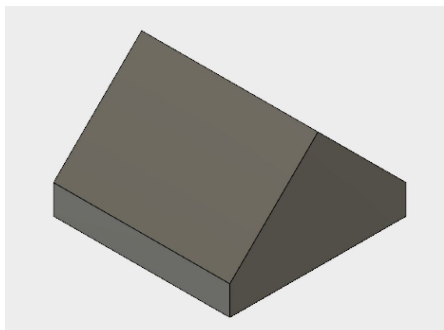

5. Window: Go to “create” -> “box”, and draw a rectangle on the left front face (any width and length is fine). For the height, type in -2 and press enter.

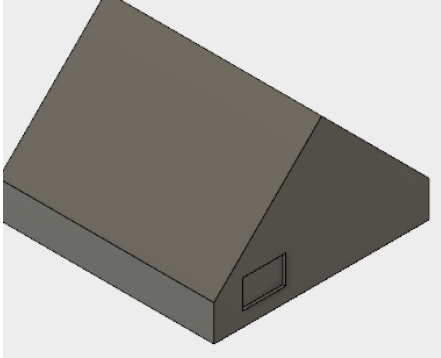

6. Create a second box within the box you just created, and for the height, type in -3 and press enter.

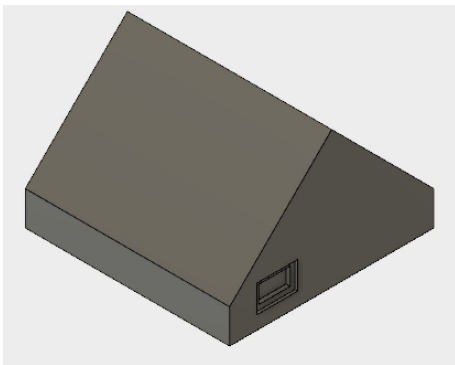

7. Door: Create a box on the other side for where a door would be (length and width don't matter as long as it connects to the base) and type in -3 for the height.

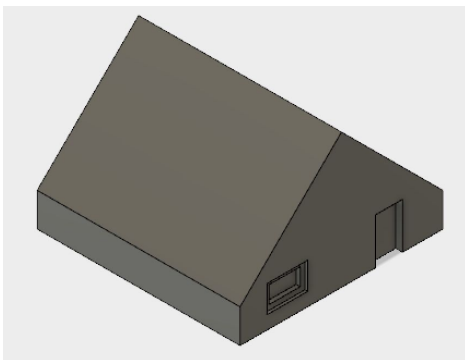

8. On the side, go to “create” -> “box” and set the dimensions to L: 24 W: 32 H: 20

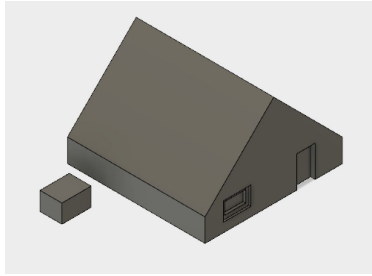

9. Select the long edges on the top of the newly created box, go to “modify” -> “chamfer”, type in 10 and press enter.

10. Highlight the entire box (drag a rectangle around it with your cursor) and it should turn blue. Go to “modify” -> “move” OR press “M”. At the bottom, check “Create copy”, and then drag the arrow in any direction.

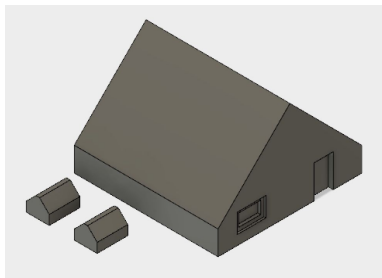

11. Now highlight both pieces and go to “move” / “M” again. Drag them so they are halfway into the left face and press enter.

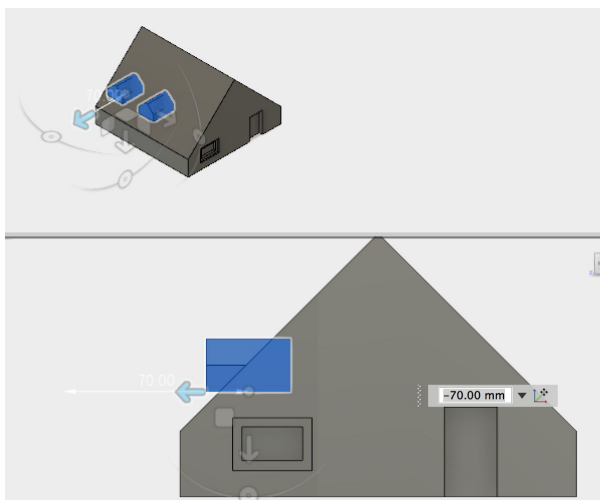



12. On the top right of every panel, you'll see a cube that looks like . Click on the corner to the right so that you now face the right side of the house.

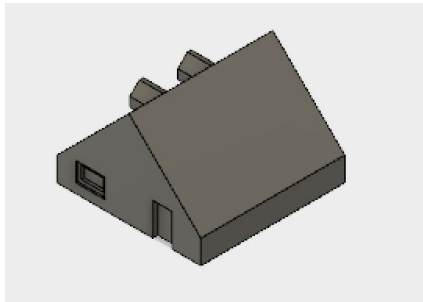

13. Create a box at the base of the house and set L: 20 W: 15. Using the down/up arrow, drag upwards and type in 90/-90.

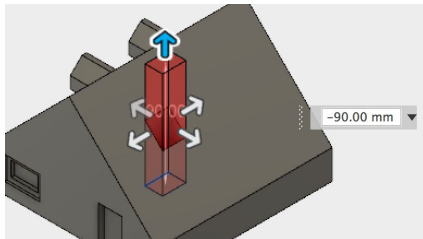

14. Under the Box menu, set the operation to “Join” and press OK.

15. To decorate the house, go to “Modify” -> “Appearance” (A key shortcut) and drag any design you want onto a face.

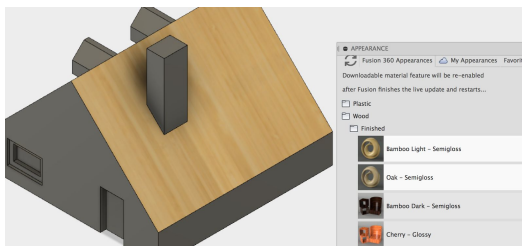

Challenge: Try and build your own house. We will all vote on the designs when everyone finishes and the winners will get a prize. If you need help feel free to ask the mentors.

You can also select the whole thing and then drag.

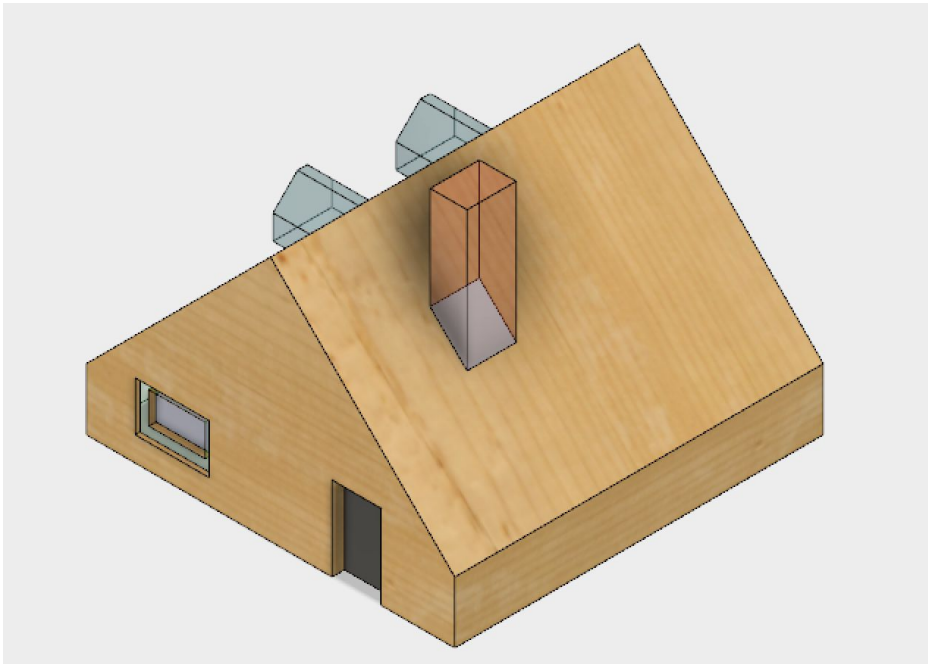
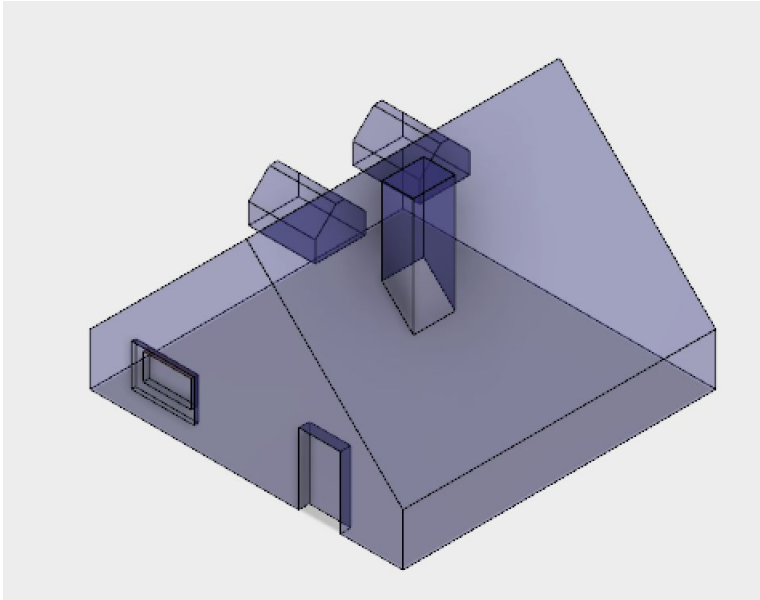

# Project - design a fidget spinner



1. First, locate the “sketch” button on the top toolbar. Click on it, and click “create sketch”.

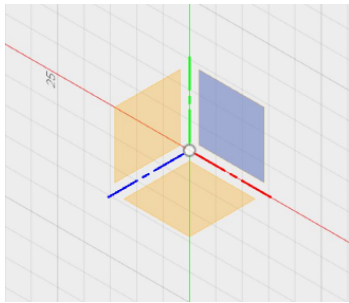

2. This should appear next, press any of the three boxes to continue.  
You should see this screen:

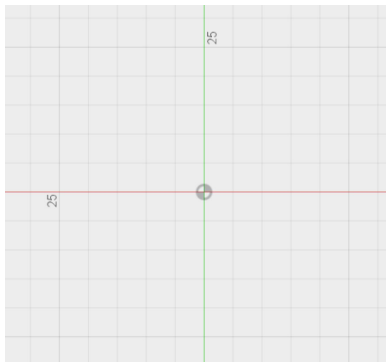

3. Once again, click on “sketch” and then hover over “circle”. A list of options should appear to the right, click on the first option, “center diameter circle”.

4. Click on the center and drag in any direction, and release.

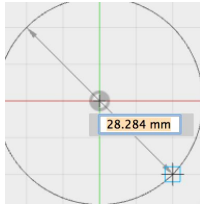

5. Type in 22 and press enter twice.

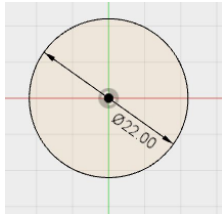

6. Now, go to “sketch”, “circle”, and choose “center diameter circle” again. (Alternatively, if you would like hexagonal corners, you can choose “sketch”, “polygon”, “circumscribed polygon”.)

7. It will give you an option to choose where to place the center point; click directly above the center at around 30 mm. Then, type in anything from 12-16 and press enter twice (6-8 for hexagons) and press enter twice. You should now see this:

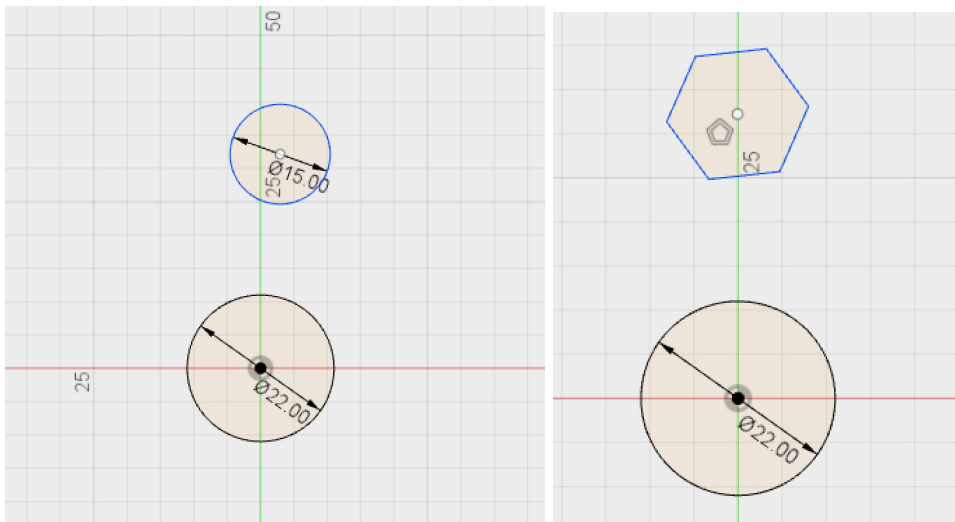



8. Next, we need to align the parts.

-Hexagon: Inside the “sketch palette” menu to the right, click on “horizontal/vertical” and then click the top edge of the hexagon. Then, click on the centers of the two circles to allow the top circle to fit perfectly on the y-axis.

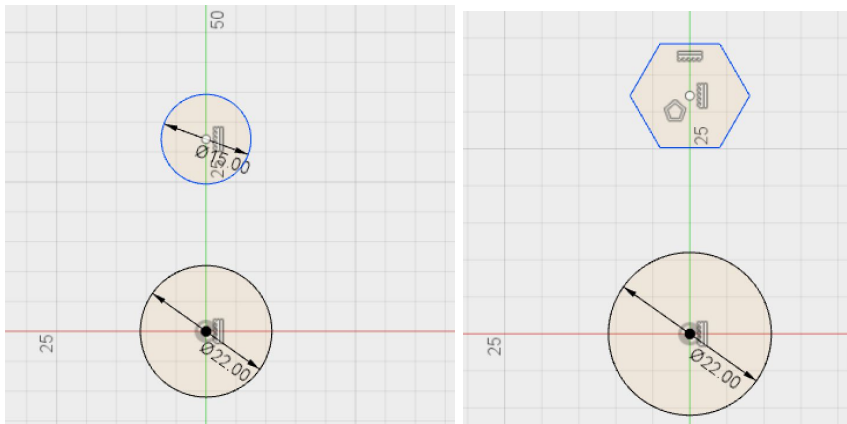

-Circle: Inside the “sketch palette” menu to the right, click on “horizontal/vertical” and then click on the centers of the two circles to allow the top circle to fit perfectly on the y-axis.



9. Press the “D” key, and the cursor should now look like this . Click on the centers of both objects and click any point towards the left. In the box given, type 30 and press enter. It should now look like this:

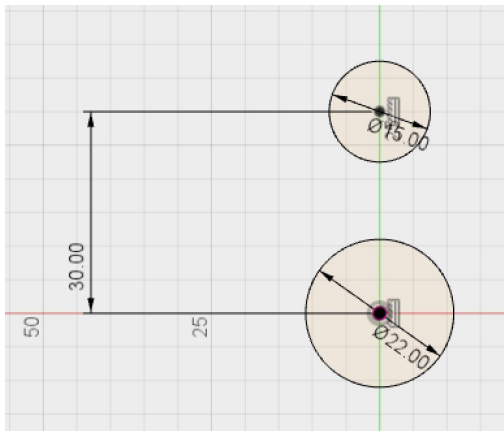

10. Press the “O” key (offset - found under “sketch”). Click on the edge of the circle, and type in 3, then press enter. Do this for both objects.

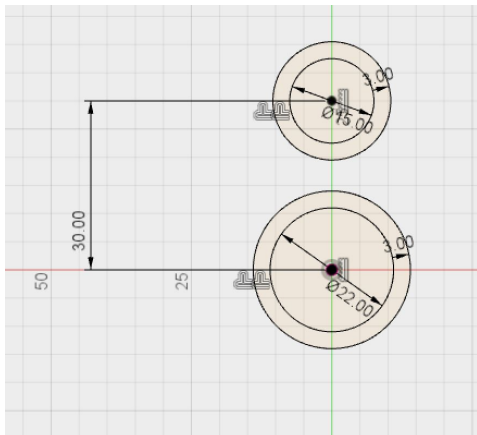

11. Click on “sketch”, then “circular pattern”. Click on the both edges of the object on top, then under the “circular pattern” menu, click on  Select . Click on the original circle’s center, and ..

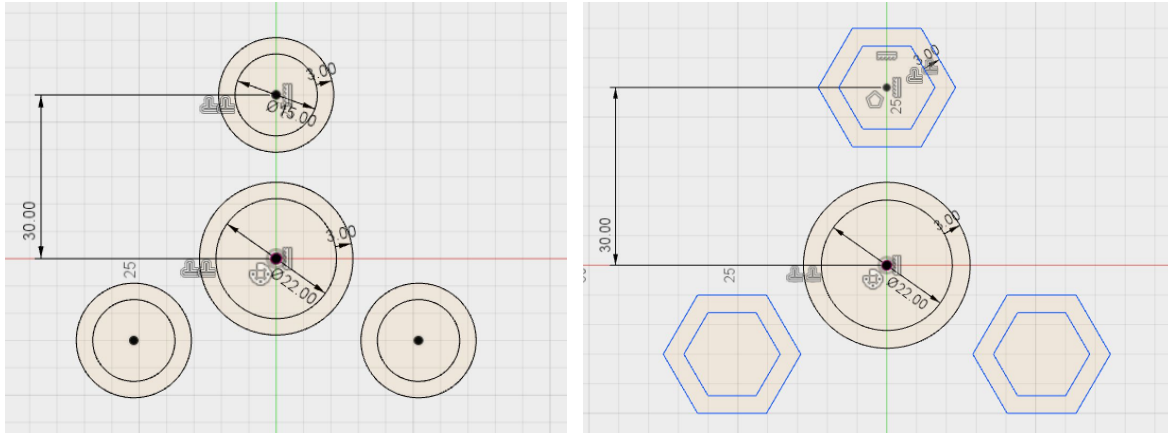

you should now see three circles/hexagons surrounding the main circle.

12. Click on “sketch”, hover over “arc”, and click on the first option, “3-point arc”. The first two points should be placed as shown below. The third point should form a tangent with the larger circle: *make sure the blue symbol appears before clicking*.

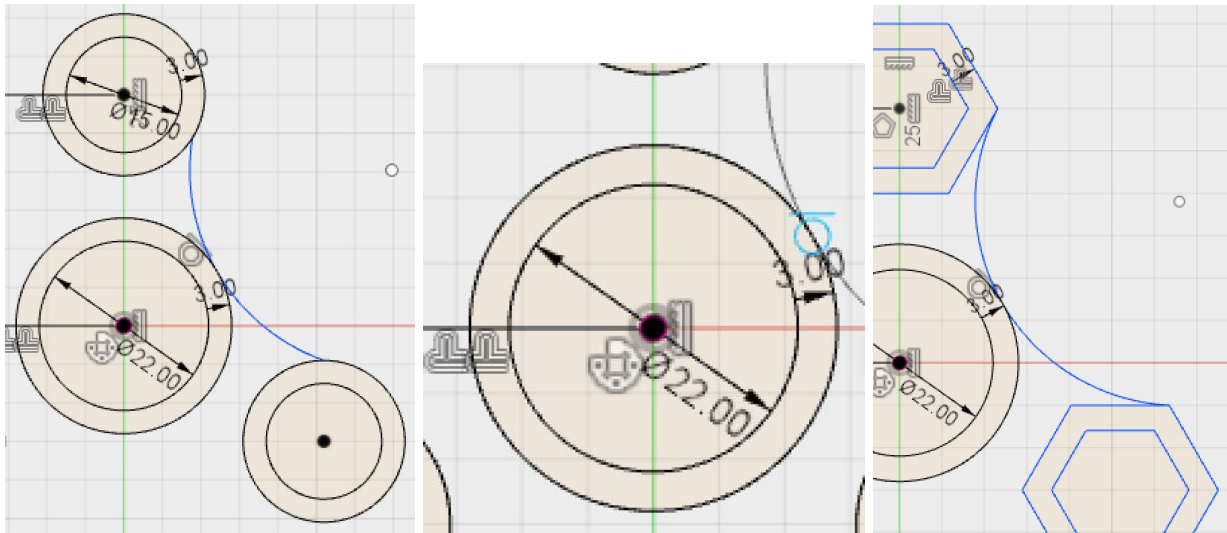

Do **NOT** do this:



(crossing inside the circles)

13. Once again, we can duplicate the arcs. Go to “sketch”, “circular pattern”, click on the arc you just made, and then click on . Then click on the center of the original circle, and click “ok”.

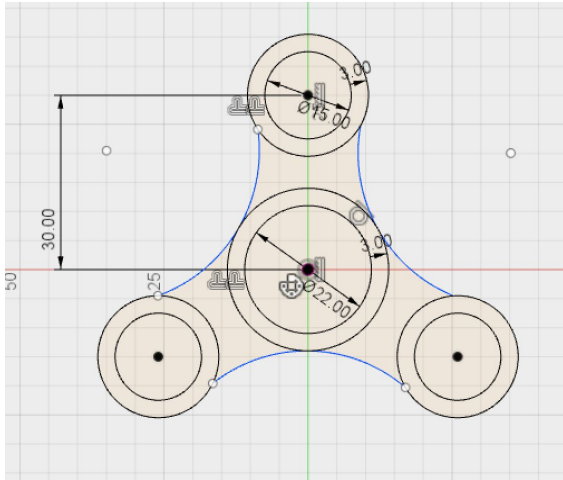

14. At the top right of the toolbar, or under “sketch palette”, click on “stop sketch”.

15. Next to “sketch”, click on “create”, and click “extrude”. Click on ALL regions except for the inner circles.

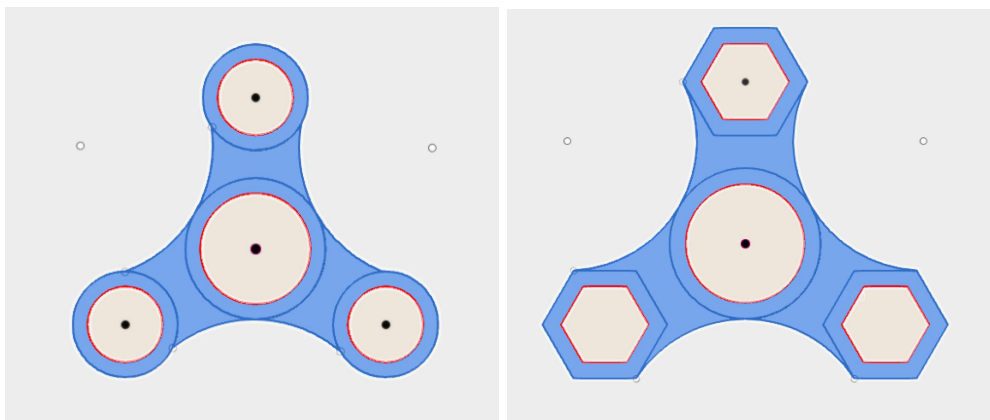

16. Nearby, there should be a box showing 0.00 mm. Change its value to 7 and press enter.

17. The fidget spinner is complete! Use the box to view it at different angles, and select the entire spinner and go to “modify” -> “appearance” to change its colors.

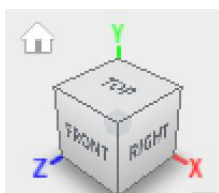

## Basic overview

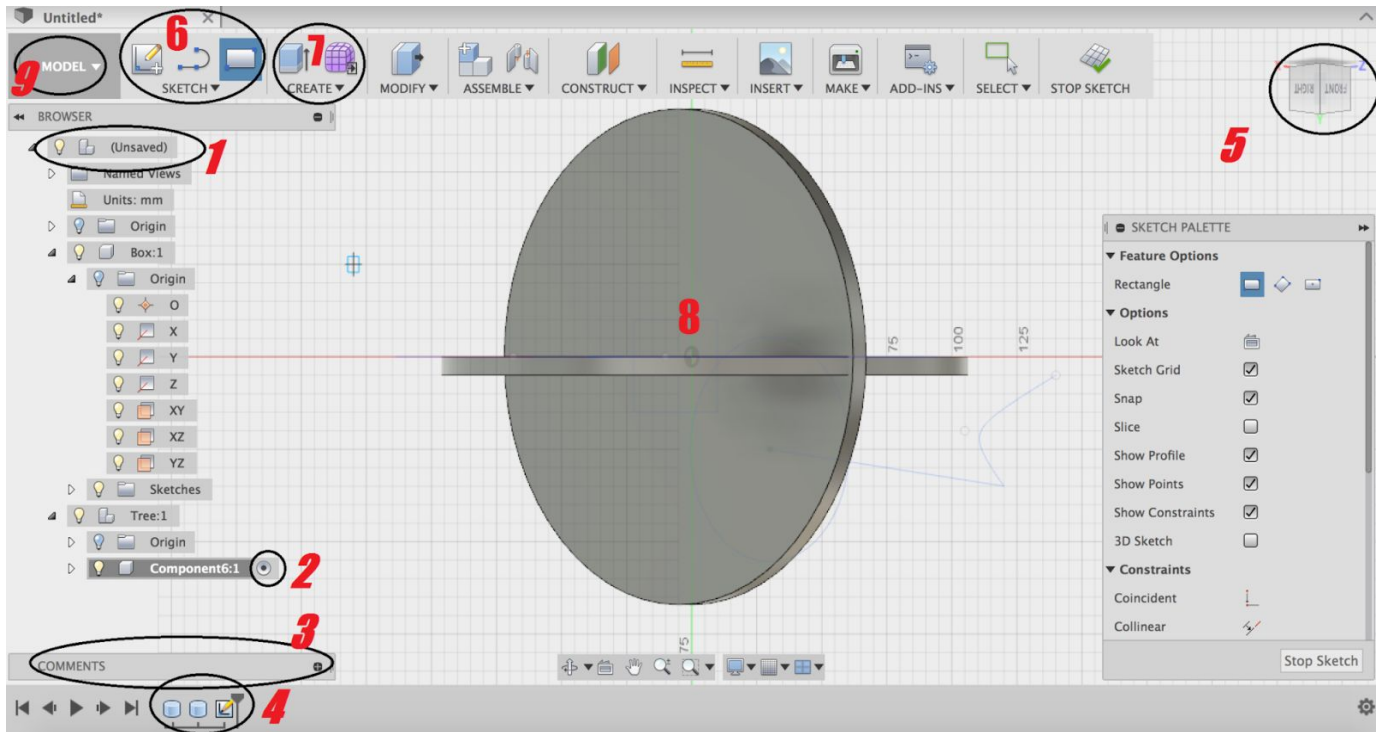

1. By right clicking on a component, you will find a list of options that allows you to create new components, remove old ones, or manage current settings.

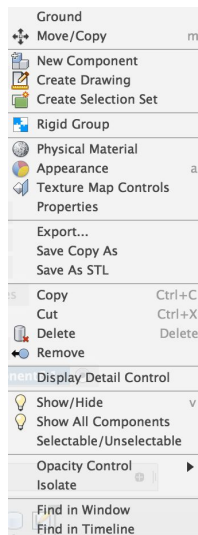

2. The eye symbol shows which component you are currently working on. To change components, hover to the right of a component and click on the empty circle that appears.

3. This allows you to leave comments for yourself, and shows the version number of the component when it was made.
4. Timeline: you can see any changes in the order they were made (similar to google doc's revision history)
5. Allows you to view the product at different angles
6. Creates lines, shapes, and other 2D figures.
7. Creates 3D figures
8. Right clicking on the figure also allows for many options:

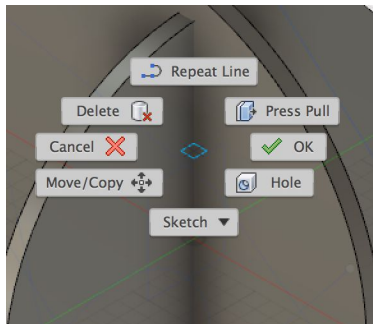

9. At the top left, you can choose what you would like to create, including drawings, animations, etc.

### Keyboard shortcuts

S = opens the toolbox, which allows you to search for objects quickly and save them for future convenience

